

Kubota®



KUBOTA DIESEL TRACTOR

M

M6060/M7060

The new M6060/M7060 deliver optimal performance and easy operation with new clean emissions engines and enhanced ergonomics.

F12/R12
Transmission
for M7060 4WD
(Factory Option)



NEW M



New clean and powerful engine

Kubota's revolutionary Common Rail System (CRS) with Exhaust Gas Recirculation system (EGR) and Diesel Particulate Filter (DPF) Muffler combine more torque at low RPM with less emissions and better fuel efficiency.

Advanced Tractors Designed and Built With You and the Environment in Mind.



F8/R8 or F12/R12* transmissions

Two powerful transmissions are available to meet your needs. Whichever you choose, you'll get smooth and comfortable shifting performance.

**Factory option on M7060 4WD only.*

Introducing the new M6060 and M7060 tractors. These new top-of-the-line M-Series tractors have been redesigned and re-equipped with advanced features including Common Rail System (CRS) with Exhaust Gas Recirculation system (EGR) and Diesel Particulate Filter (DPF) Muffler for powerful yet clean and economical performance, and a more ergonomically designed Cab for easier operation, giving you the confidence you deserve to tackle tough jobs with ease, while still being gentle on the environment. Work hard, but do it with absolute pride with the new M6060/M7060.

KUBOTA DIESEL TRACTOR
M6060/M7060

Kubota's clean low-noise engine delivers performance.

NEW ENGINE



Kubota New Engine with Common Rail System (CRS)

M6060: 56 PTO HP

M7060: 64 PTO HP

Low Noise and Low Vibration

To help reduce operator fatigue and stress, the V3307 CRS engine has been specially designed to minimize noise and vibration. This is accomplished through several innovative technologies. Noise is reduced through a ladder frame crankshaft support, giving the engine a stiffer structure and thus lower noise. Also a gear train on the flywheel side reduces the gear chattering noise caused by crankshaft torsion. Vibration is lowered through the application of compact, built-in balancers.

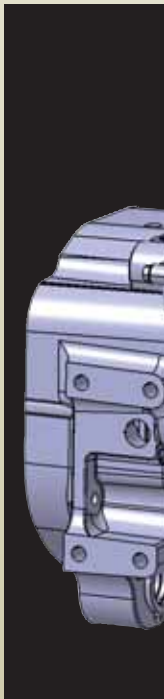

Constant RPM Management

The M6060/M7060 engine features a new electronic control of engine RPM. Activating the system keeps engine revolution nearly constant with a push of the switch, preventing a reduction in PTO speed and enabling stable operation. It makes working with PTO-driven implements much more efficient.

Tier IV Emission Regulations

The V3307 CRS engine for M6060/M7060 complies with Tier IV EPA emission regulations.



Diesel Particulate Filter (DPF) Muffler



**Constant RPM Management Switch*

LINE



4-valve, Center-Direct Injection System

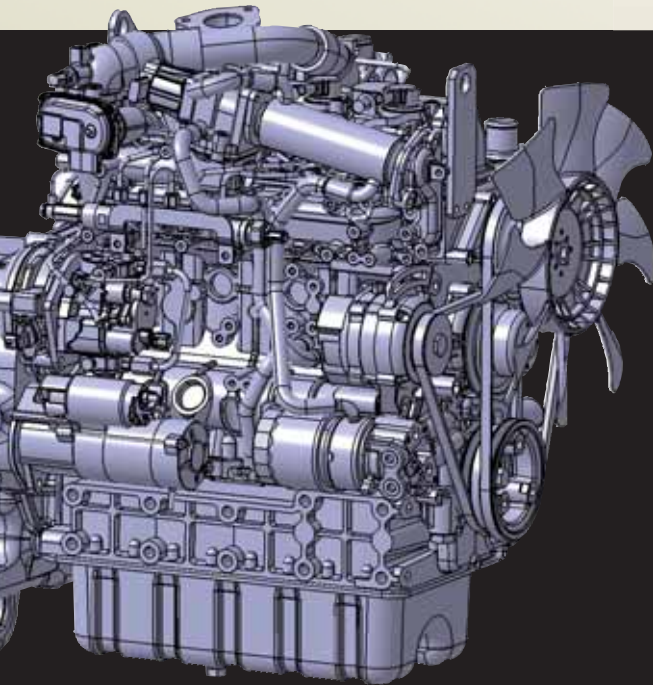

Common Rail System (CRS) with Exhaust Gas Recirculation system (EGR) and Diesel Particulate Filter (DPF) Muffler

The CRS electronically controls the timing and amount of injected fuel providing high-pressure injections in stages, rather than all at once for an optimal combustion rate that results in greater efficiency, better fuel economy and less engine noise. Its combination with the Diesel Particulate Filter (DPF) Muffler and Exhaust Gas Recirculation system (EGR) reduces emissions to meet the latest emission regulations.



• Keep Productive At Your Farm By Using Constant RPM Management

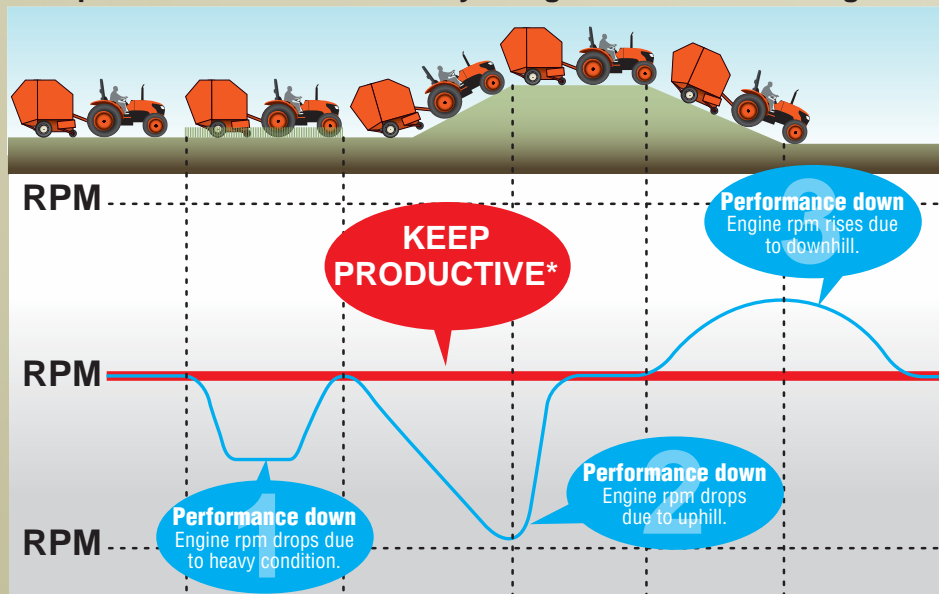

— Constant RPM Management Switch ON
 — Constant RPM Management Switch OFF

*The engine speed drops when the load exceeds the engine performance.

Note:

In a mechanically-controlled engine, the engine speed changes according to increases and decreases in the load. For example, when working in a hilly area, the load increases and engine speed drops while ascending a slope, and conversely the load drops when descending. These changes in engine speed affect the travel speed and PTO-driven implements. In order to minimize these effects, the operator must make fine adjustments to the travel speed and hand throttle lever.

When the Constant RPM Management switch is turned "On", the engine speed will be kept nearly constant in response to a certain level of work fluctuations. This improves the accuracy of work without the need for troublesome manipulation of the travel speed and hand throttle lever.

There is a limit to the range within which a constant speed can be maintained. If a load exceeding the engine performance is applied, the engine speed will drop. The purpose of Constant RPM Management is not to increase the engine power.

A choice of two transmissions gives you the tractor performance you need with less hassle.

TRANSMISSIONS

F8/R8 Transmission

The synchronized four speeds of the main shift and a high/low range supply tractors with 8 Forward and 8 Reverse speeds.



F12/R12 Transmission

(Factory option on M7060HD/HDC models)

For heavy-duty work such as plowing, hay work and heavy trailer applications M7060HD/HDC models can be equipped with an F12/R12 transmission. This transmission features six speeds of the main shift and a high/low range giving it a total of 12 Forward and 12 Reverse speeds.

Traveling speed for M7060 F8/R8 Models with 16.9-30 Rear Tires @ rated engine RPM

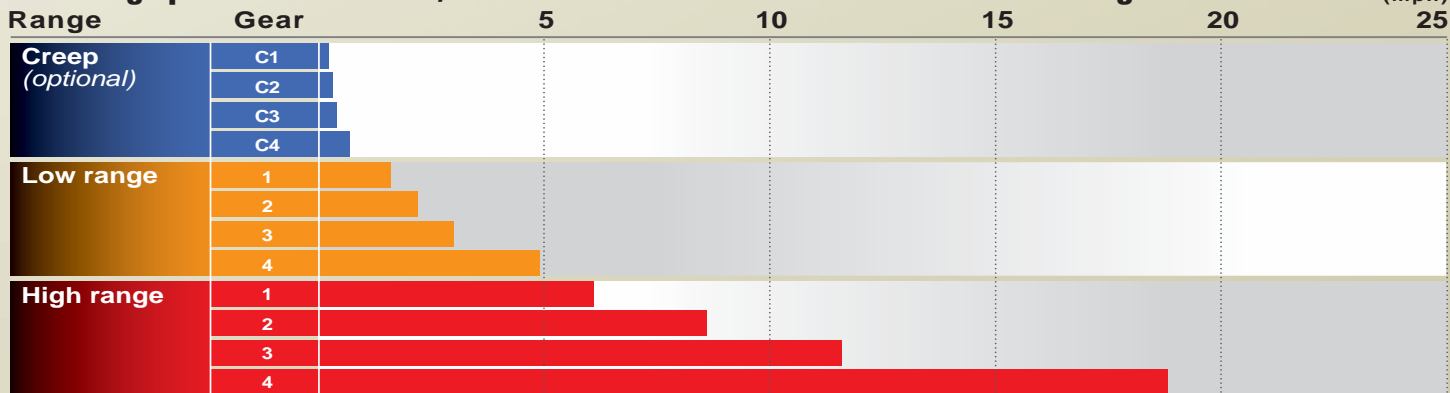

Traveling speed for M7060 F12/R12 Models with 16.9-30 Rear Tires @ rated engine RPM*

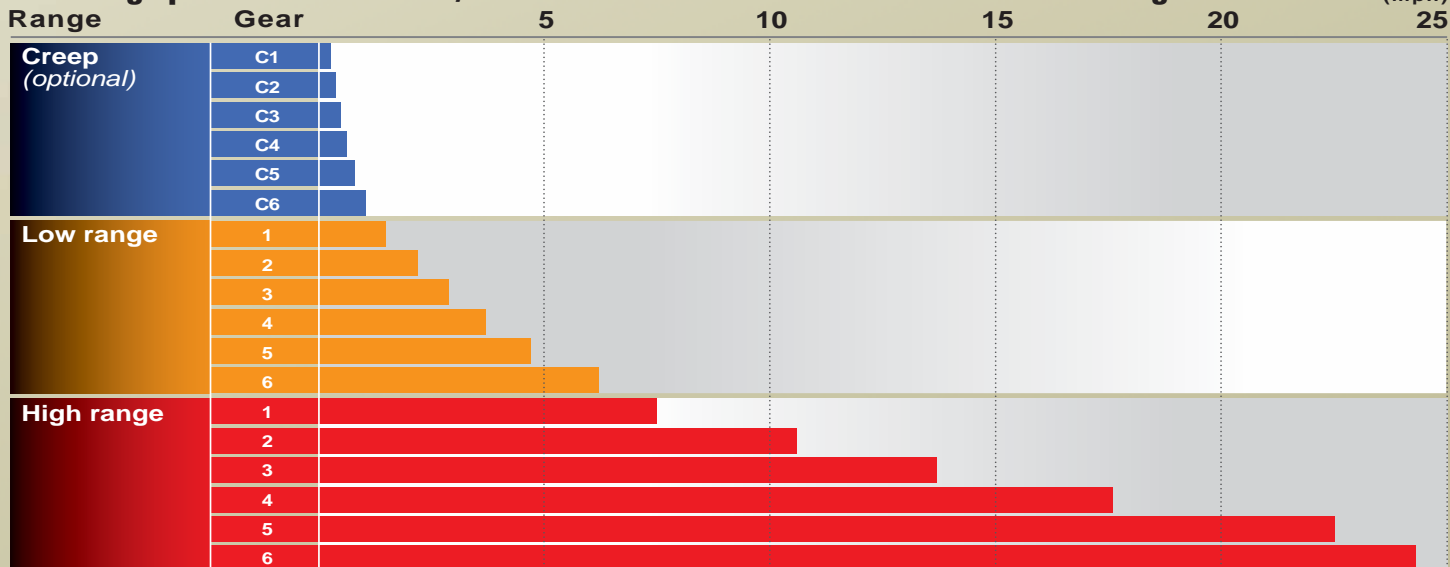

*When H6 gear is selected, over drive function limits the maximum engine revolutions at 1960 rpm for better fuel economy.

SION

Over Drive (F12/R12 models only)

When H6 gear is selected, over drive function limits the maximum engine revolutions at 1960 rpm for better fuel economy.

Hydraulic Shuttle

Better than ever, our Hydraulic Shuttle for the M6060/M7060 makes shifting between forward and reverse smooth and effortless. With the Hydraulic Shuttle, a column-mounted lever, conveniently located next to the steering wheel, does all the work. Boost productivity, especially while using loaders, by eliminating the need to depress the clutch every time you change directions.



Hydraulic Wet Disc Brakes (F12/R12 models only)

To decrease operator effort and increase overall tractor longevity, M7060 F12/R12 models now come standard with Hydraulic Wet Disc Brakes. These brakes require less pedal effort and retain high performance efficiency even after repeated heavy-duty work.

Transmission Parking Lock (F12/R12 models only)

The parking lock can be operated with the main shift lever for easier operation. This lock is highly durable and reliable, providing precise parking on any terrain*.
** Level ground is recommended*



Multiple Wet Disc Clutch

The multi-plate wet disc clutch provides durability and a long operating life.

Limited Slip Differential

Limited Slip Differential on the front helps you maintain a stable travel speed should the drive wheel on either side of the tractor slip. A standard feature on the M7060 4WD models, Limited Slip Differential is perfect when reliable traction is essential.

Easy to shift 4WD Engagement

Switching the 4-wheel drive on and off is easy and quick, and done with one simple switch (Electro-Hydraulic on the go) for F12/R12 models and one simple lever (Mechanical on the go) for F8/R8 models. Best of all, there's no need to stop the tractor even when moving out of a field onto a road, so you can stay productive. The 4WD indicator on the LED readout lets you know you're in 4WD. (Do not engage while carrying heavy loads, or when rear wheel is spinning.)



(Picture shows an Electro-Hydraulic on the go switch on F12/R12 models)



More space and more visibility make our Cab a great place to work.

ULTRA GRAND

Ultra Grand Cab

The innovative and stylish design of the new M6060/M7060 Cab gives the operator more comfortable and spacious environment year around.

Curved Upper Windshield

The curved upper windshield increases upward visibility, making it especially handy when raising the Front Loader.



Rounded Glass

We've rounded the Cab glass of our M-Series tractors to provide the operator with more visibility and a more spacious feel—ideal for long days inside the Cab. Furthermore, we've increased the glass coverage area on the Cab door, which makes it easier to get in and out of the Cab.

Wide Fenders

Wide and rounded fenders protect the operator from mud splashes.



Front Wiper

To increase operator visibility on rainy days, the M-Series has a pantograph style front wiper. The unique design of this wiper gives it a wider coverage area.



CAB



A spacious and ergonomically designed Cab brings comfort to the workplace.

COMFORT

New Functional Platform

The M6060/M7060 Cab has been redesigned for better ergonomics. All levers (except the 4WD lever) and electrical switches are located on the right side for easy access and continuous operations.

Comfortable Seat

Specifically designed to absorb shock and reduce operator fatigue. Standard reclining function and arm rests further enhance comfort, and ROPS models feature a handy holder in the seat-back to store manuals. For greater shock-absorbing performance, Cab models can be optionally equipped with the air-ride seat suspension.

Cab Headroom

The arched beam in the front of the Cab and relocated A/C components allow M6060/M7060 to extend the height of the roof. This feature not only increases headroom, it also increases overall visibility, especially while using the loader.



Easy-Step Tilt Steering Wheel

The steering wheel of the cab gets out of the way when the operator is dismounting the tractor. Just step on a pedal and raise the steering wheel to its original position.

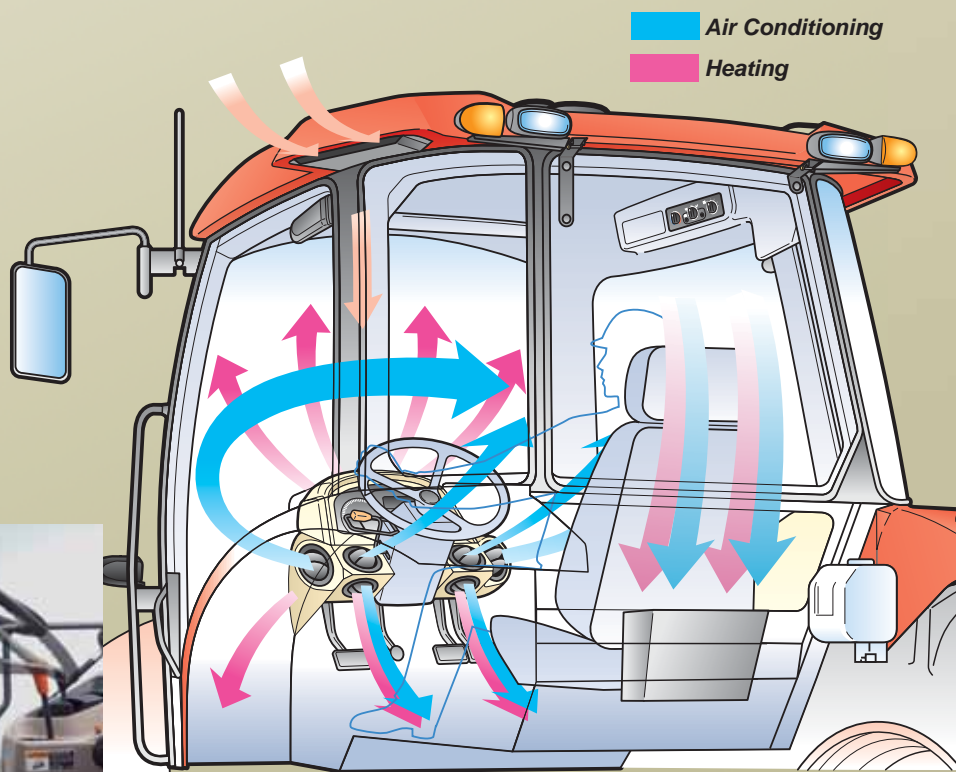



Heater/Air Conditioner

The heating and cooling unit is now located under the seat. The overall air circulation in the Cab has been optimized by the Cab's rounded glass as well as by placing the air outlets in the dash tower to keep you cooler on hot summer days and warmer on cold winter days, for year around comfort.

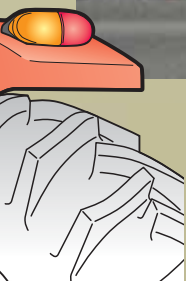

Air is circulated throughout the windshield to prevent icing, frosting and fogging.

Standard Equipment

- Front halogen work lights
- Front windshield wiper and washer
- Rear halogen work lights
- Interior dome light
- External left and right mirrors
- Sun visor
- Cup holder
- Cigarette lighter
- 7-pin trailer coupler
- 3-pin 12V coupler

Options

- Rear wiper and washer
- Rear defogger
- 100 amp alternator
- Air ride seat suspension
- CD/radio with weather band
- Cassette radio with weather band

Long-lasting strength, durability and reliability to endure and tackle just about various jobs with ease.

HEAVY D

Hydraulics

The hydraulics on the M-Series are state-of-the-art. External hydraulic cylinders improve the lifting power and offer easier maintenance. The M6060/M7060 offers a large pump capacity (hitch and remote) of 16.2 gpm for F12/R12 models. As a result, the front loader cycle times are short, increasing productivity and facilitating operation. One (SCD) hydraulic remote valve is standard, with the option to add up to 2 more, plus an optional flow control valve to control the oil flow volume.

Hydraulic Independent PTO

Pulling, lifting, cutting or baling; the hydraulic independent PTO makes your toughest work easier. Self-modulation engagement with an Electric PTO Switch means implements like a rear cutter engage smoothly. The PTO brake engages when the clutch is shut off and securely holds the PTO shaft. The PTO clutch can be

hydraulically engaged and disengaged on the go. This means mowing, operating hay equipment or spraying orchards are all made more efficient.

3-Point Hitch

The Category I / II 3-point hitches provide fast and simple attachment of rear-mounted implements. On the M6060 and M7060 it is 3307lbs (1500kg).

Telescopic Lower Link Ends

The telescopic lower link ends, standard on M6060/M7060 models, further facilitate implement attachment.



Fuel Saving Economy PTO

F12/R12 models offer standard 540/540E PTO (Optional for F8/R8 models). For economy PTO operation, change the lever for 540E position. Engine is run at lower RPM to save fuel and reduce operating noise while still turning PTO shaft at 540 RPM. Engine speed is limited to 2132 RPM by economy PTO operation.



UTILITY

Bevel-Gear Front Axle

The bevel-gear front axle provides the M6060/M7060 with greater all-around maneuverability. It enables M6060/M7060 tractors to achieve a tighter turning radius than ever before--an amazing 55 degrees. This makes easy work of jobs in tight spaces. Limited Slip Differential on the front and Differential Lock on the rear are standard features, offering increased stability and traction on challenging ground conditions.



The M-Series Front Loader puts power and liftability front and center.

FRONT LO

Powerful Design

The Kubota M-Series Front Loader provides superior lifting power, perfect for farm use. The loader has also been fully integrated into the tractor design with a slanted boom to match the tractor's hood. This not only gives the M-Series a sleeker look it supplies the operator with more visibility and clearer sight lines to the bucket and loader sides.

Lifting Power and Height

Two separate boom cylinder fulcrum points (Power position and Height position) give you the option to increase the M-Series Front Loader lifting power or height based on your needs. When using the pallet fork or bale spear operators have the option to set the fulcrum to give more height. For bucket work, the lower setting offers more power.

4-Bar Linkage

Thanks to the 4-bar bucket linkage, the rollback and dumping angle has been increased for quicker scooping and dumping.

2-Lever Quick Coupler

This standard M-Series feature makes attaching buckets, bale spears and pallet forks quick and easy.



Protected Cylinder Tubes

To better protect the tractor hydraulics and offer the operator more visibility, the hydraulic tubes are neatly tucked inside the loader boom. Hydraulic tube covers further provide protection from wear and tear.



Frame

The frame of the front loader maintains its sturdy, thick steel frame, but its design has been simplified by removing braces and connectors. This helps to lessen effort and shorten the time it takes to attach the loader and offers increased visibility.



LOADER



Joystick Control

Located in front of the control console for easy access, the joystick offers you the ability to control the movement and speed of the loader with a single lever. The Series Circuit makes simultaneous boom and bucket operation possible, while the Regenerative Bucket Dump Circuit enables quick dumping for efficient operation with quick cycle times.

Kubota Shockless Ride (KSR)

The KSR absorbs loader shock and reduces operator fatigue. This option is perfect if your tasks include a great deal of tight turns or lifting and dumping of heavy loads. It effectively takes the "bounce" out of handling round bales.



Single-Lever Hydraulic Quick Coupler

The optional quick coupler allows the operator the ability to attach all four hoses at once. This makes attaching and detaching quick and easy.



3rd Function Valve

The optional 3rd function valve broadens the scope of the front loader operation by enabling the use of a grapple bucket and various other hydraulically controlled attachments. The 3rd function valve can be activated with buttons located on the grip of the joystick.

Rubber Caps

Rubber caps prevent grease drips helping to keep the operator's clothes clean. The caps also give the loader a more appealing look.

Quick-Mount Attach/Detach

Attach or detach the front loader quickly without the use of tools. The boom stands and mounting pins make this task a snap, allowing an extra measure of productivity and tractor versatility.



Model	LA1154	
Tractor Applications	M6060, M7060	
Boom Cylinder Fulcrum	Height position	Power position
Maximum Lift Height (Pivot Pin)	in. (mm)	132.7 (3370) 117.2 (2977)
Clearance w/Attachment Dump	in. (mm)	101.5 (2577) 85.5 (2172)
Reach @ Maximum Height	in. (mm)	18.0 (458) 35.9 (911)
Maximum Dump Angle	degrees	43 60
Reach w/Attachment on Ground	in. (mm)	76.7 (1947)
Maximum Rollback Angle	degrees	43
Digging Depth (When Bucket is Level)	in. (mm)	5.3 (134) 4.4 (111)
Overall Height in Carry Position	in. (mm)	61.9 (1573)
Material Bucket Width / Capacity (Heaped)	in. /cu.ft.(m ³)	72 / 19.43 (0.55)
Lift Capacity (Bucket Center)	lbs. (kg)	2326 (1055) 2536 (1150)
Lift Capacity to Maximum Height at Pivot Pin	lbs. (kg)	2469(1120) 2928(1328)
Raising Time to Full Height w/out Load ^{**}	second	4.7
Lowering time w/out Load (powerdown) ^{**}	second	3.6
Attachment Rollback Time	second	3.0
Attachment Dumping Time	second	2.8

^{**}w/Standard valves.

Specifications

Model	M6060				M7060			
	2WD		4WD		2WD		4WD	
ROPS / CAB	HFC		HD / HDC		HFC		HD / HDC HD12 / HDC12	
Engine	V3307-CR-TE4							
Type (Make : KUBOTA)	4 cylinder in-line, Common Rail System, direct Inject.							
No. of cylinders/Aspiration	4 / turbocharged							
Engine net power* HP (kW)	63.5 (47.4)				71 (53.0)			
PTO power HP (kW)	56 (41.7)				64 (47.7)			
Total displacement cu.in. (cc)	203 (3331)							
Rated engine RPM ROPS/CAB	2400							
Fuel tank capacity ROPS/CAB gal. (ℓ)	18.5 (70) / 23.8 (90)							
Alternator ROPS/CAB	45 Amp / 60 Amp (100 Amp : OPT)							
Transmission								
No. of speeds	F8 / R8						F12 / R12	
Main gear shift	Fully synchronized (4 speed)						Fully synchronized (6 speed)	
Shuttle shift	Hydraulic-shuttle							
Main clutch type	Multiple wet disc							
Brake type	Mechanical wet disc						Hydraulic wet disc	
Differential lock (Front / Rear)	N / A		N/A / Mechanical		N / A		Limited Slip Differential / Mechanical	
4WD clutch type	-		Mechanical on-the-go		-		Mechanical on-the-go Electro-Hydraulic on-the-go	
PTO								
Type	Live-independent PTO, electro-hydraulic clutch with brake							
Speed rpm	540 (540 / 540E:OPT)						540 / 540E	
Hydraulics								
Pump capacity (3-Point Hitch) ROPS/CAB gpm (ℓ/min.)	11.0 (41.6)						16.2 (61.5)	
3-Point Hitch	Telescopic lower link ends, Telescopic Stabilizers							
Category	I / II							
Control system	Position, draft (top link sensing) & mixed control							
Lift capacity at 24 in. behind lift point lbs. (kg)	3307 (1500)							
Cylinder type	Two external cylinders							
No. of standard remote valves	1 (2nd, 3rd & flow control valve optional)							
Other features								
4WD system	N / A		Bevel gear type		N / A		Bevel gear type	
Steering	Hydrostatic power steering							
Tilt steering	Standard							
Hood type / Pedal type	Full open, slanted, steel / Hanging							
Deck type (ISO-mounted w/rubber mat)	Semi-flat on ROPS models, full-flat on CAB models							
Panel type	Electronic							
Fender shape	Wide, round							
Standard tire size								
Front	7.5-16		9.5-24		7.5-16		9.5-24	
Rear	16.9-28				16.9-30			
Dimensions & weight								
Overall length ROPS models in. (mm)	-		138.0 (3505)		-		138.0 (3505)	
CAB models in. (mm)	142.7 (3625)		138.0 (3505)		142.7 (3625)		138.0 (3505)	
Overall height top of ROPS in. (mm)	96.9 (2460)				97.2 (2470)			
top of CAB in. (mm)	100.6 (2555)				101.0 (2565)			
Overall width (minimum) in. (mm)	73.0 (1860)							
Wheelbase ROPS models in. (mm)	-		83.1 (2110)		-		83.1 (2110)	
CAB models in. (mm)	84.4 (2145)		83.1 (2110)		84.4 (2145)		83.1 (2110)	
Crop clearance (Front axle) in. (mm)	18.1 (460)							
Tread width Front in. (mm)	55.9-71.7 (1420-1820)		55.9, 59.8 (1420, 1520)		55.9-71.7 (1420-1820)		55.9, 59.8 (1420, 1520)	
Rear in. (mm)	55.9-67.7 (1420-1720)							
Turning radius (w/o brake) ft. (m)	10.81 (3.3)		11.8 (3.6)		10.8 (3.3)		11.8 (3.6)	
Tractor weight ROPS models lbs. (kg)	-		5005 (2270)		-		5027 (2280)	
CAB models lbs. (kg)	5226 (2370)		5358 (2430)		5248 (2380)		5380 (2440)	

*SAE J1349

The company reserves the right to change the above specifications without notice. This brochure is for descriptive purpose only.

Some of the items pictured in this brochure are optional, and not standard equipment. Please contact your local Kubota dealer for warranty, safety or product information.

For your safety, KUBOTA strongly recommends the use of a Rollover Protective Structure (ROPS) and seat belt in almost all applications.

Not for sale in Nebraska.

©2012 Kubota Corporation



KUBOTA TRACTOR CORPORATION

Kubota Tractor Corporation, 3401 Del Amo Boulevard, Torrance CA 90503
 Western Division: 1175 S. Guild Ave., Lodi, CA 95240 Tel (209) 334-9910
 Central Division: 14855 FAA Boulevard, Fort Worth, TX 76155 Tel (817) 571-0900
 Northern Division: 6300 at One Kubota Way, Groveport, OH 43125 Tel (614) 835-1100
 Southeast Division: 1025 Northbrook Parkway, Suwanee, GA 30024 Tel (770) 995-8855

Visit our web site at: www.kubota.com

